

MVH2000A Series

High Performance Analog Relative Humidity Sensor



General Description

[Patents protected & patents pending]

MEMS Vision’s relative humidity (RH) sensors are built by combining the company’s revolutionary MoSiC[®] technology with its extensive ASIC design experience. This combination enables high levels of performance, such as fast RH measurement response time and high accuracy.

The technology also offers a very robust proprietary sensor-level protection, ensuring excellent stability against aging and harsh environmental conditions such as shock and volatile chemicals.

The highly miniaturized smart sensors are fully calibrated and provide an analog relative humidity output that is ratiometric to the supply voltage. This sensor type supports systems operating in high noise environments where sensors with digital outputs cannot be used.

The micro-Watt levels of power consumption of these sensors make them the ideal choice for portable and remote applications.

MEMS Vision’s RH sensors offer the industry’s most competitive performance-to-price value, for a wide range of applications and end users.

Features

Fast RH response time
 - Typical 4 seconds time constant

High accuracy
 - Relative humidity (MVH2003A):
 ±2.5% RH typ. (20 – 80%RH, 25°C)

10% to 90% ratiometric analog output voltage

Fully calibrated analog relative humidity output with temperature compensation

Extended supply voltage range of 1.8V – 5.5V

Very low power consumption
 - 130 µA avg. current (1.8V supply)

Small form factor for use in compact systems
 - 3 × 2.4 × 0.8 mm DFN-style LGA package

User Benefits

- **Long Term Stability and Reliability:** Proprietary sensing structures and protection technology, robust biasing circuitry, and self-diagnosis algorithms ensure accurate and repeatable measurements.
- **Analog Output:** Supports systems operating in high-noise environments where digital outputs are susceptible to errors.
- **Fully Calibrated System:** Built-in digital calibration ensures high accuracy measurements and linear behavior under varying sensing environments.

Applications

The MVH2000A series is ideal for use in environmental sensing for consumer electronics, automotive, industrial, agricultural, and other sectors. Some application examples include:

OEM products	Battery-powered systems	HVAC systems
Instrumentation	Drying	Building automation
Medical equipment	Meteorology	Data logging
White goods	Refrigeration equipment	Industrial equipment

Table of Contents

1. Pin Configuration 3

2. Pin Assignment and Connection Diagram 3

3. Functional Description..... 3

4. Chip Performance Summary..... 4

5. Relative Humidity Sensor Performance 5

 5.1 Accuracy Tolerances..... 5

 5.2 Normal Operating Conditions 5

6. Sensor Operation..... 6

 6.1 Sensor Startup 6

 6.2 Measurement Signal Output..... 6

 6.3 Conversion of the Output Signal 6

7. Package and PCB Information 8

 7.1 Package Drawing 8

 7.2 Tape and Reel Information 9

 7.3 Soldering Information 9

 7.4 PCB Layout Considerations 10

8. Storage and Handling Information..... 10

9. Part Numbers 11

List of Tables

Table 1: Pin assignment..... 3

Table 2: MVH2000A Series Specifications..... 4

Table 3: Voltage ripple, settling time, and effective resolution vs. C_{FILT} ($R_{FILT} = 50k\Omega$). 6

List of Figures

Fig. 1: Diagram of pin configuration (top view)..... 3

Fig. 2: DFN-style LGA package. 3

Fig. 3: Connection diagram. 3

Fig. 4: MVH2000A series functional diagram. 3

Fig. 5: Relative humidity tolerances at a temperature of +25°C..... 5

Fig. 6: Relative humidity tolerances across temperature. 5

Fig. 7: Relative humidity vs. the RH output analog voltage..... 7

Fig. 8: LGA package drawing. 8

Fig. 9: LGA package land pattern (top view)..... 8

Fig. 10: Packaging tape drawing..... 9

Fig. 11: Recommended lead-free soldering profile..... 9

Fig. 12: Thermal isolation of sensor using milled PCB openings. 10

1. Pin Configuration

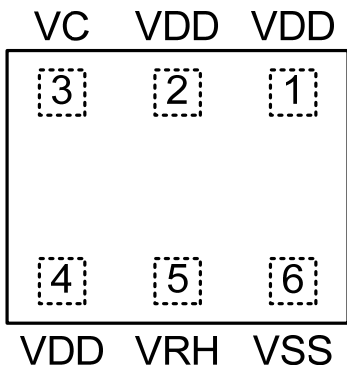

Fig. 1: Diagram of pin configuration (top view).

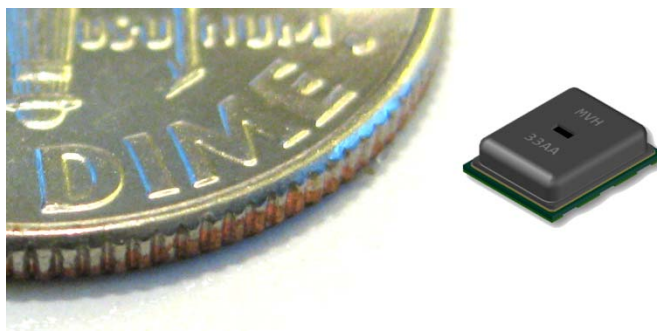

Fig. 2: DFN-style LGA package.

2. Pin Assignment and Connection Diagram

Table 1: Pin assignment.

Pin	Name	Function
1	VDD	Connected to positive supply
2	VDD	Connected to positive supply
3	VC	A 0.1 μ F decoupling capacitor
4	VDD	Positive supply
5	VRH	Analog RH output voltage ¹
6	VSS	Negative supply or ground

¹Requires an RC filter to smooth out the PDM output signal.

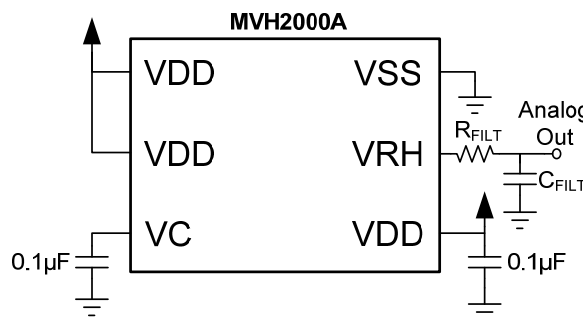

Fig. 3: Connection diagram.

3. Functional Description

The MVH2000A series are digital sensors at their core, that accurately measure relative humidity across temperature, and then convert the result to an analog output.

An analog-to-digital converter (ADC) with a configurable resolution is interfaced with an analog multiplexer and two sensors in order to allow for the measurement of both relative humidity and temperature. High precision biasing and clock generation ensures stable operation

over a wide temperature range. The sensor can be used to measure the ambient relative humidity in real-time and produces a pulse-density modulation (PDM) signal that can be filtered for analog transmission of the acquired data.

Calibration data and compensation logic are integrated within the system such that the chip does not require any user calibration, and can provide accurate measurements over a wide range of temperature and humidity levels.

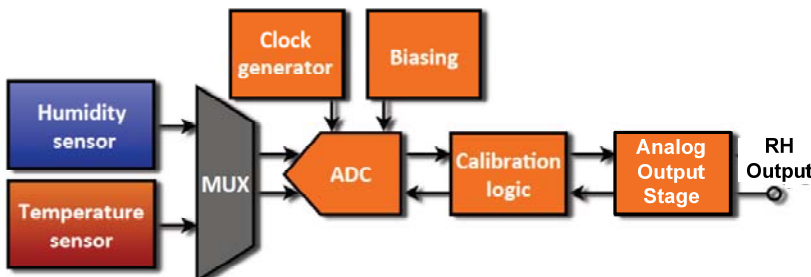

Fig. 4: MVH2000A series functional diagram.

4. Chip Performance Summary

Table 2: MVH2000A Series Specifications.
At $T_A = +25^\circ\text{C}$, $V_{DD} = +1.8\text{ V}$ to $+5.5\text{ V}$ unless otherwise noted.

PARAMETER		CONDITION	MIN	TYP	MAX	UNITS
RELATIVE HUMIDITY						
Range			0		100	%RH
Accuracy Tolerance ²	MVH2003A	20% to 80% RH		±2.5	±3.5	%RH
	MVH2004A			±3.5	±4.5	
Resolution ³				14		bits
Hysteresis					±1.0	%RH
Non-Linearity from Response Curve	MVH2003A	20% to 80% RH		±0.15	±0.25	%RH
	MVH2004A			±0.15	±0.25	
Long-term Stability				0.1	0.25	%RH/yr
Response Time Constant ⁴ (τ_H)		20% to 80% RH Still air	3.0	4.0	6.0	sec.
CHIP TEMPERATURE RANGE						
Operating Range			-40		125	°C
Storage Range			0		60	°C
ELECTRICAL SPECIFICATIONS						
Operating Supply Voltage (V_{DD})			1.8	3.3	5.5	V
Power up Time				10	15	ms
Average Current ⁵ (I_Q)		Using a 50k Ω resistor in RC filter ⁶	140	180	210	μA

²For monotonic increases in the range of 10% to 90% RH, after the sensor has been stabilized at 50% RH. See Fig. 5 and Fig. 6 for more details.

³Depends on the analog filter values. See section 6 for more details.

⁴From initial value to 63% of total variation.

⁵Minimum, typical, and maximum average currents are given at a 1.8V, 3.3V, and 5.5V V_{DD} , respectively.

⁶See section 6 for more details.

5. Relative Humidity Sensor Performance

5.1 Accuracy Tolerances

The typical and maximum relative humidity tolerances for the MVH2000A series sensors at 25°C are shown in Fig. 5, and the typical accuracy tolerances across temperature are shown in Fig. 6.

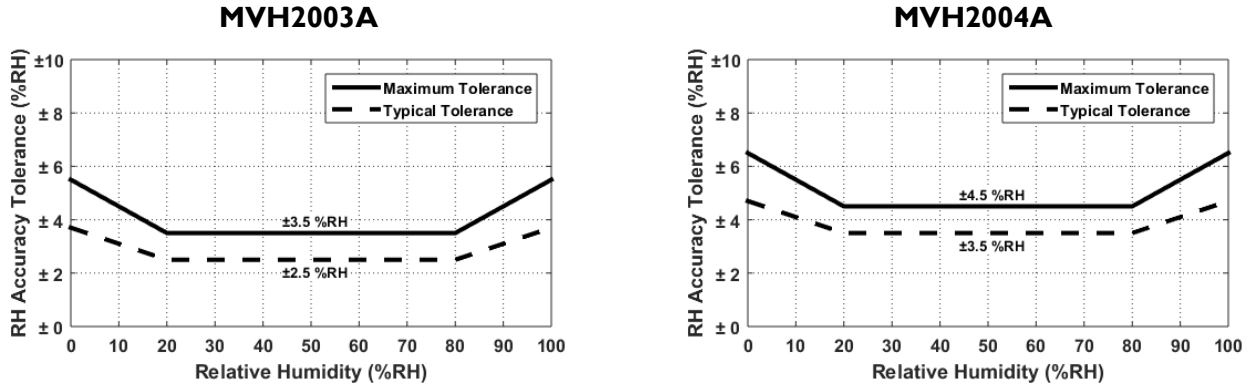

Fig. 5: Relative humidity tolerances at a temperature of +25°C.

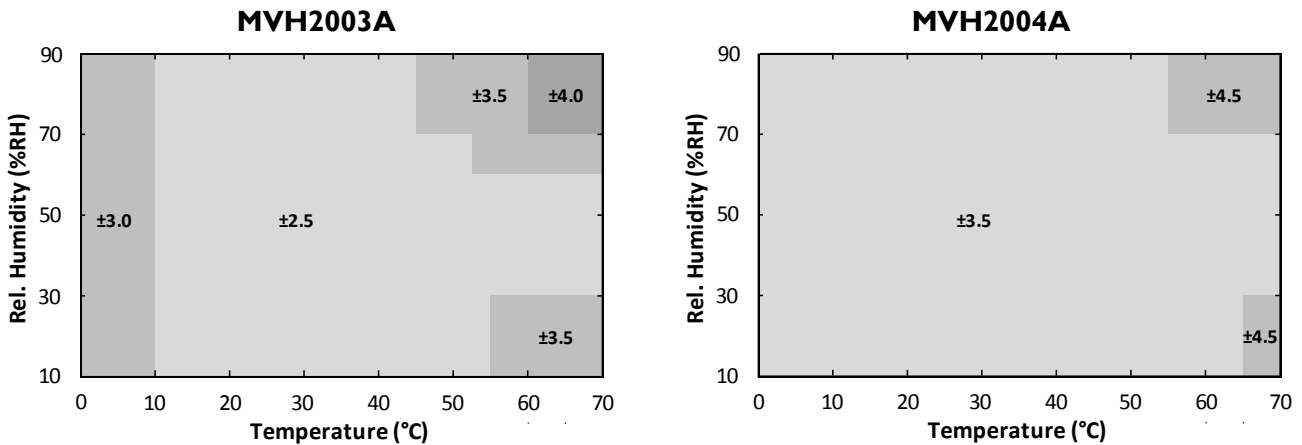

Fig. 6: Relative humidity tolerances across temperature.

5.2 Normal Operating Conditions

The sensor has been optimized to perform best in the more common temperature and humidity ranges of 10°C to 50°C and 20% RH to 80% RH (non-condensing), respectively. If operated outside of these conditions for extended periods of time, especially at high humidity levels, the sensors may exhibit an offset. In most cases, this offset is temporary and will gradually disappear once the sensor is returned to normal temperature and humidity conditions. The amount of the shift and the duration of the offset vary depending on the duration of exposure and the severity of the relative humidity and temperature conditions. The time needed for the offset to disappear can also be decreased by using the procedure described in Section 8 of this datasheet.

6. Sensor Operation

6.1 Sensor Startup

The typical startup time of the MVH2000A series sensor is 10 ms, after which relative humidity measurement data will be provided on the corresponding pin.

6.2 Measurement Signal Output

The relative humidity data is provided as a pulse density modulation (PDM) signal. This signal needs to be filtered using an additional off-chip simple RC circuit to create an analog voltage signal. The configuration of the RC filter is shown in Fig. 3, and the resistance needs to be at least 50 k Ω for proper operation. The capacitor should be chosen according to the desired ripple on the signal line, which will determine the effective resolution that can be achieved. Values for the voltage ripple, the settling time of the signal, and the effective resolution for different filter capacitance values when using a 50 k Ω resistor are shown in Table 3.

Table 3: Voltage ripple, settling time, and effective resolution vs. C_{FILT} ($R_{FILT} = 50k\Omega$).

Filter Capacitance (nF)	Voltage Ripple (mV / V_{DD})	0 to 90% Settling Time (ms)	RH Resolution (%RH)
22	3.93	2.5	8 bits
100	0.86	11.5	10 bits
470	0.18	54.1	12 bits
2200	0.04	253.0	14 bits

For a different (higher) R_{FILT} value, the normalized ripple (mV / V_{DD}) and settling time (in ms) can be calculated as:

$$\text{Voltage Ripple (mV / } V_{DD}) = \frac{4324}{R_{FILT} C_{FILT}},$$

$$\text{Settling Time (ms)} = 0.0023 * R_{FILT} C_{FILT},$$

where R_{FILT} is in k Ω and C_{FILT} is in nF.

6.3 Conversion of the Output Signal

The voltage levels of the filtered analog output signal are ratiometric with V_{DD} . The default output range for the relative humidity is from 10% to 90%, and custom output ranges are also supported. (Please contact support@mems-vision.com for further details.)

Each MVH2000A sensor is individually calibrated, so that a standard linear fitting equation can be used to obtain the measured RH value. The equation to convert the output voltage to relative humidity is given as:

$$RH = 125 * \frac{V_{RH}}{V_{DD}} - 12.5.$$

This is shown graphically in Fig. 7.

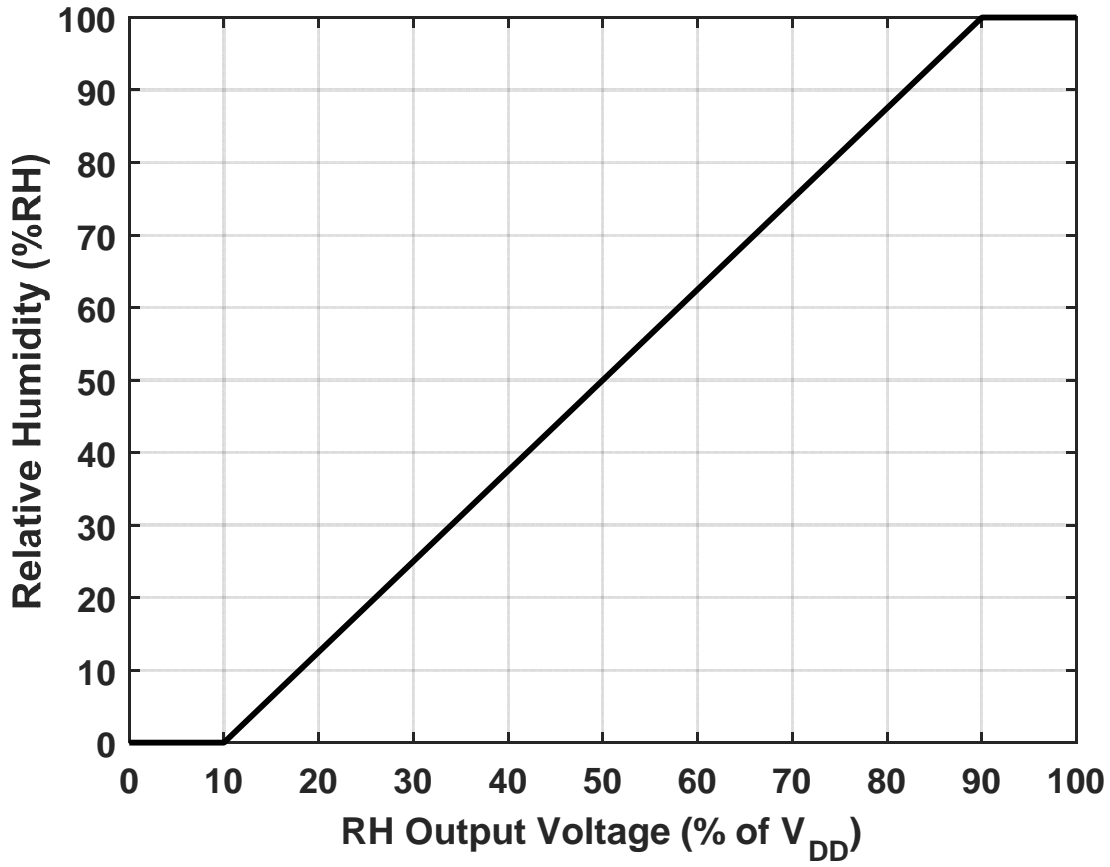

Fig. 7: Relative humidity vs. the RH output analog voltage.

7. Package and PCB Information

The MVH2000A series sensors are packaged in a 3 × 2.41 × 0.8 mm 6-pin dual-flat no-leads (DFN)-style LGA package.

7.1 Package Drawing

The mechanical drawing of the LGA package is shown in Fig. 8, and a suitable land pattern for soldering the sensor to a PCB is shown in Fig. 9. The units used for all dimensions are mm.

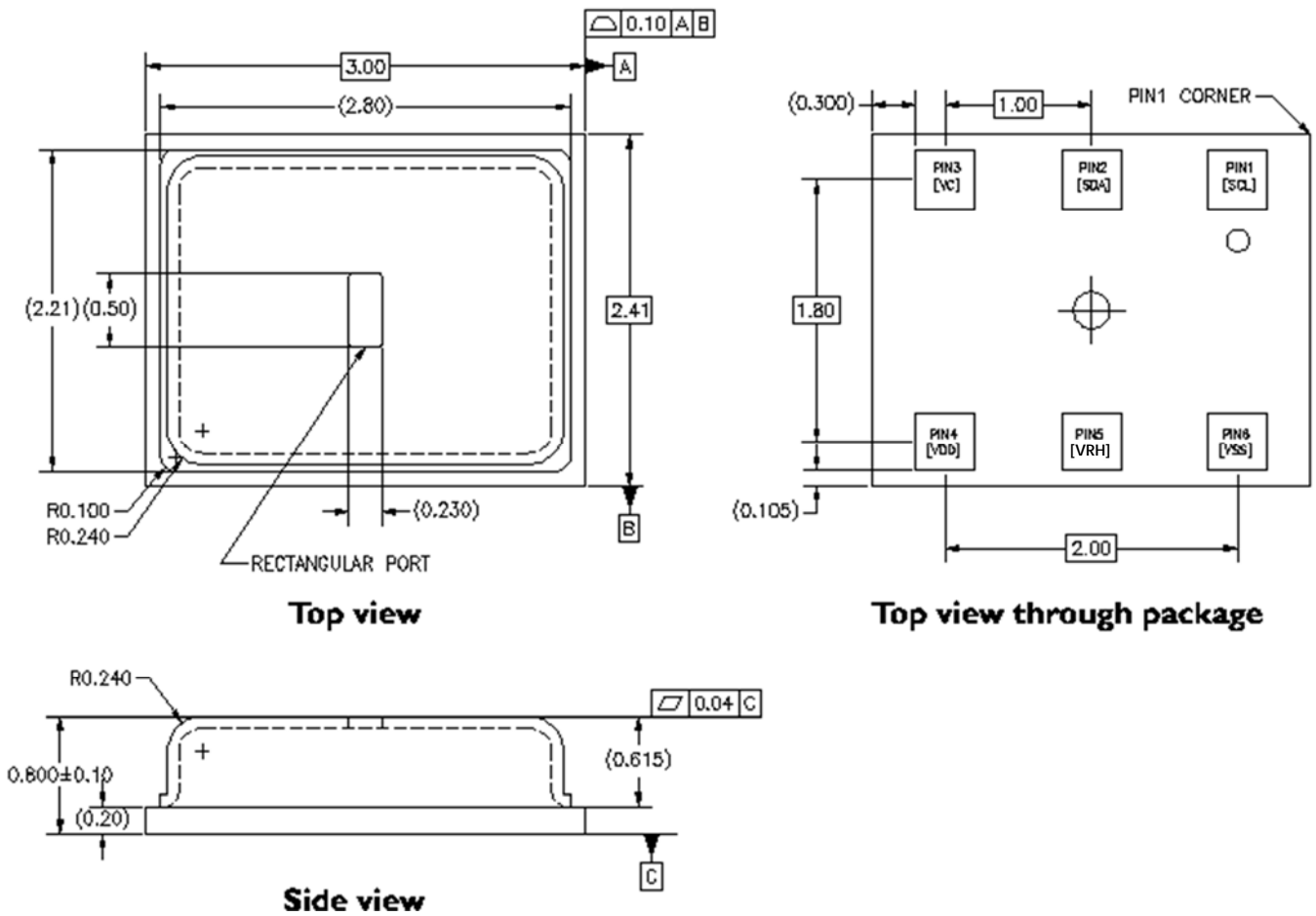

Fig. 8: LGA package drawing.

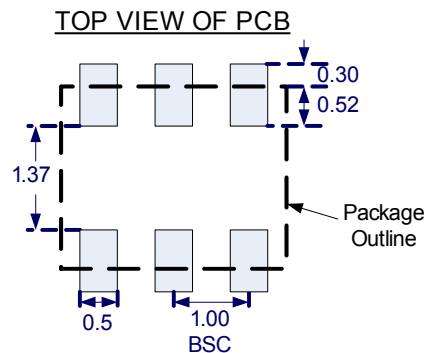

Fig. 9: LGA package land pattern (top view).

7.2 Tape and Reel Information

The MVH2000A series sensors can be shipped in tape and reel packaging, enclosed in sealed anti-static bags. Standard packaging sizes are 400, 1500, and 2500 units (please contact MEMS Vision for other volumes). The tape has a 470 mm leader (117 pockets) and a 410 mm trailer (103 pockets). A drawing of the packaging tape is shown in Fig. 10, which also shows the sensor orientation.

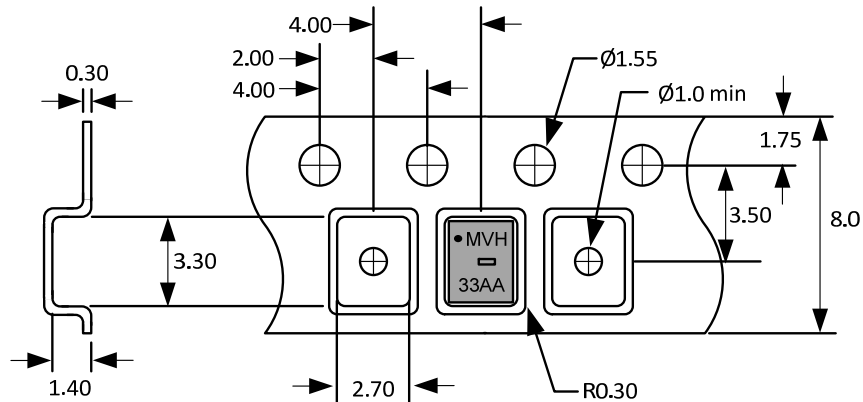

Fig. 10: Packaging tape drawing.

7.3 Soldering Information

Standard reflow ovens can be used to solder the MVH2000A series sensor to the PCB. The peak temperature (T_p) for use with the JEDEC J-STD-020D standard soldering profile is 260°C. For manual soldering, the contact time must be limited to 5 seconds at up to 350°C. In either case, if solder paste is used, it is recommended to use ‘no-clean’ solder paste to avoid the need to wash the PCB.

Note that reflow soldering is recommended for optimal performance. The recommended lead-free (RoHS compliant) reflow soldering profile is shown in Fig. 11.

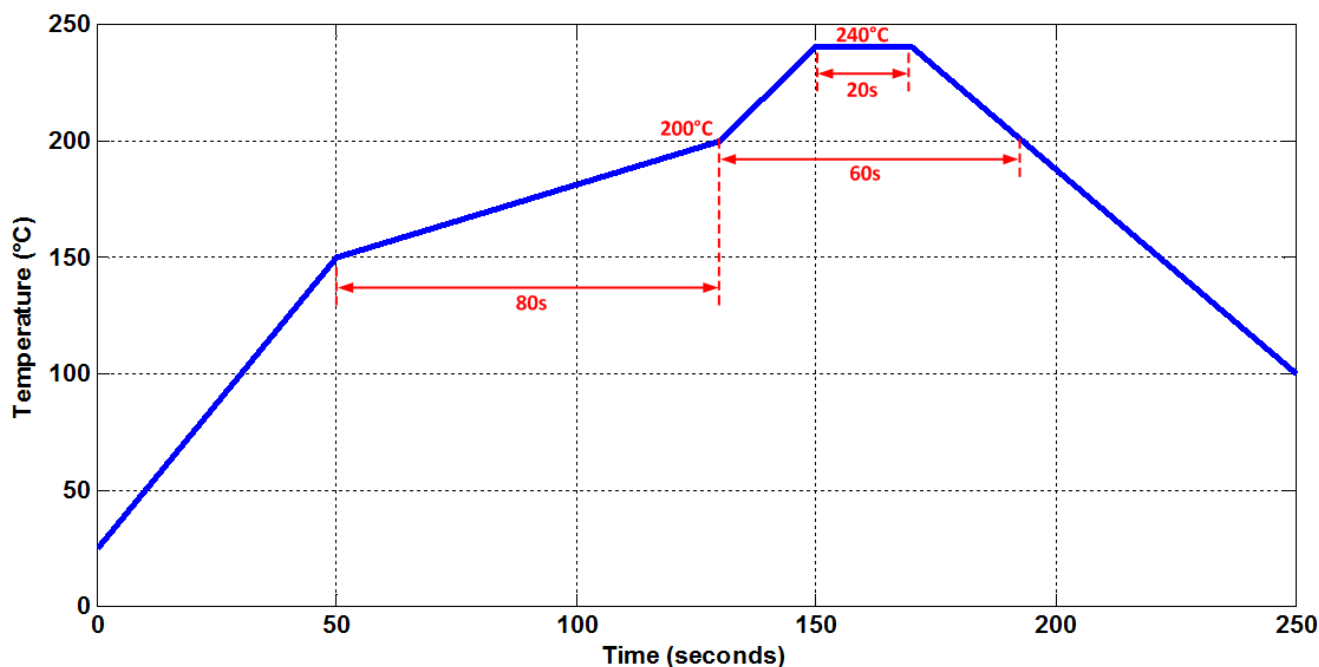

Fig. 11: Recommended lead-free soldering profile.

After soldering, the humidity sensor element should be exposed to a humidity of 75% RH for at least 12 hours in order to rehydrate the element. Otherwise, there may be an initial offset in the relative humidity readings, which will slowly disappear as the sensor gets exposed to ambient conditions.

7.4 PCB Layout Considerations

When designing the PCB, undesired heat transfer paths to the MVH2000A series chip must be minimized. Excessive heat from other components on the PCB will result in inaccurate relative humidity measurements. As such, ***solid metal planes for power supplies should be avoided in the vicinity of the sensor*** since these will act as thermal conductors. To further reduce the heat transfer from other components on the board, openings can be milled into the PCB as shown in Fig. 12.

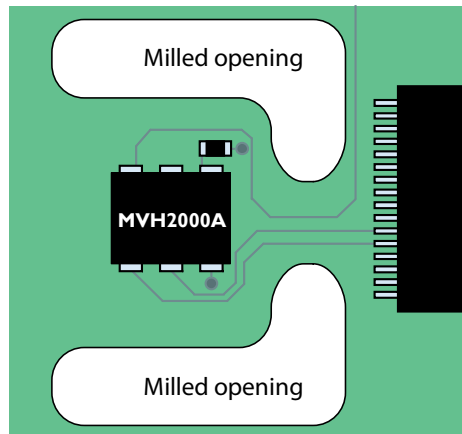

Fig. 12: Thermal isolation of sensor using milled PCB openings.

8. Storage and Handling Information

Once the sensors are removed from their original packaging, it is recommended to store them in metal-in antistatic bags. Polyethylene antistatic bags (light blue or pink in color) should be avoided as they may affect sensor accuracy.

The nominal storage conditions for the MVH2000A series chip are at temperatures in the range of 10 to 50°C and at humidity levels within the range of 20% to 60% RH. If the chip is stored outside of these ranges for extended periods of time, the relative humidity sensor readings may exhibit an offset. The sensor can be brought back to its calibration state by applying the following reconditioning procedure:

1. Baking at a temperature of 100°C with a humidity < 10% for 10 -12 hours.
2. Rehydrating the sensor at a humidity of 75% RH and a temperature between 20 to 30°C for 12 to 14 hours.

Note that the sensor may also return to its calibrated state if left at ambient conditions for a longer period of time.

9. Part Numbers

MVH2000A	
MVH2003A	3 × 2.4 × 0.8 mm 6-pin DFN-style LGA package
MVH2004A	3 × 2.4 × 0.8 mm 6-pin DFN-style LGA package

© 2018 MEMS Vision Worldwide. All rights reserved.

MEMS Vision, its logo, and MoSiC[®] are trademarks or registered trademarks of MEMS Vision International Inc., Canada, and its subsidiaries in Canada and other countries.

Other trademarks used herein are the property of MEMS Vision or their respective third party owners.

The information in this document is believed to be accurate in all respects at the time of publication, but shall not be regarded as a guarantee of conditions or characteristics. MEMS Vision assumes no responsibility for errors and omissions, and disclaims responsibility for any consequences resulting from the use of information included in this document. MEMS Vision also assumes no responsibility for the functioning of features or parameters not explicitly described herein. MEMS Vision reserves the right to make changes without further notice. MEMS Vision makes no warranty, representation, or guarantee regarding the suitability of its products for any particular purpose, nor does MEMS Vision assume any liability arising out of the application or use of any product or circuit and, specifically DISCLAIMS ANY AND ALL LIABILITY, including without limitation consequential or incidental damages, as well as warranties of non-infringement of intellectual property rights of any third party.

MEMS Vision products are not designed, intended, or authorized for use in applications intended for safety, emergency stopping, or supporting or sustaining life, or for any other application in which the failure of the MEMS Vision product could create a situation where personal injury or death may occur. Should Buyer purchase or use MEMS Vision products for any such unintended or unauthorized application, Buyer shall indemnify and hold MEMS Vision harmless against all claims and damages.

www.mems-vision.com

info@mems-vision.com